



Ευρωπαϊκή Ένωση  
Ευρωπαϊκό Κοινωνικό Ταμείο



Κυπριακή Δημοκρατία



Διαρθρωτικό Ταμείο  
της Ευρωπαϊκής Ένωσης στην Κύπρο

Το Έργο συγχρηματοδοτείται από το Ευρωπαϊκό Κοινωνικό Ταμείο της Ε.Ε. και την Κυπριακή Δημοκρατία



ΥΠΟΥΡΓΕΙΟ ΠΑΙΔΕΙΑΣ, ΠΟΛΙΤΙΣΜΟΥ, ΑΘΛΗΤΙΣΜΟΥ ΚΑΙ ΝΕΟΛΑΙΑΣ  
Διεύθυνση Μέσης Τεχνικής και Επαγγελματικής Εκπαίδευσης και Κατάρτισης

ΟΝΟΜΑΤΕΠΩΝΥΜΟ: .....

ΤΑΞΗ: .....

Να κατασκευάσετε το συμμετρικό των πιο κάτω σχημάτων ως προς την ευθεία ε.

1)

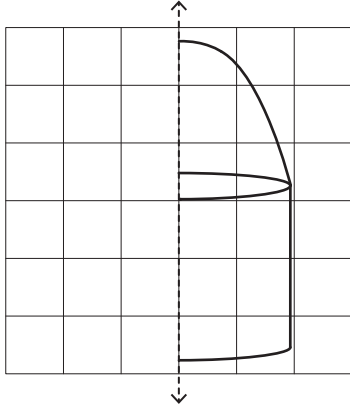

2)

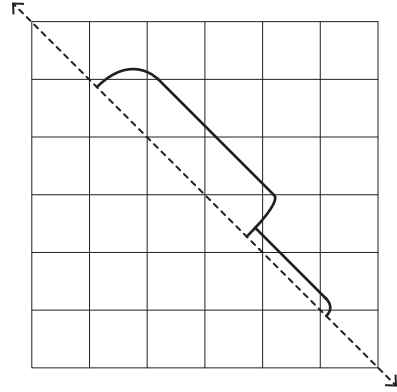

3)

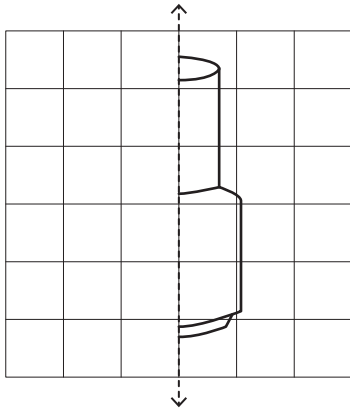

4)

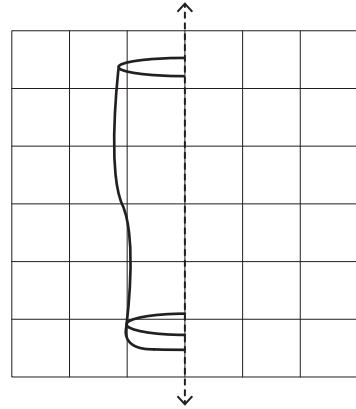

5)

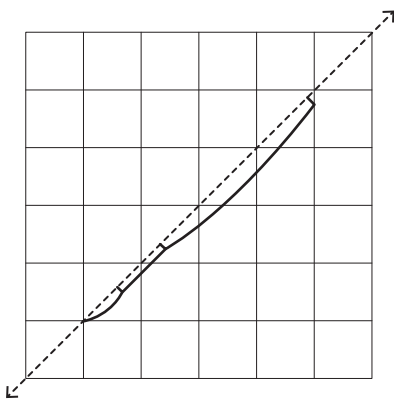

6)

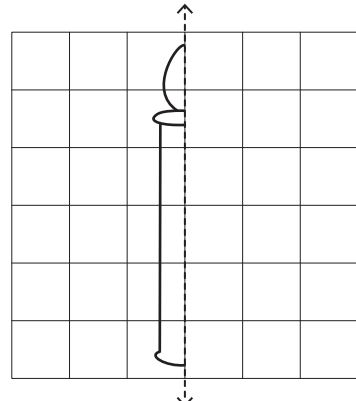

7)

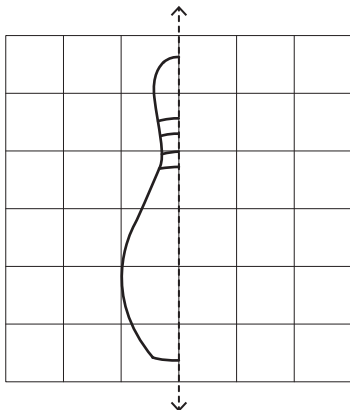

8)

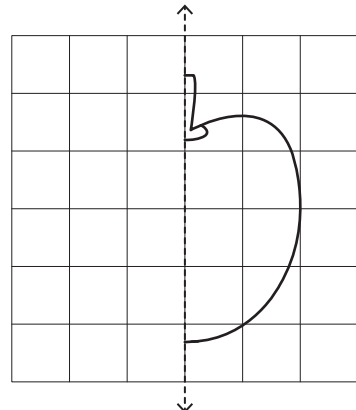

1)

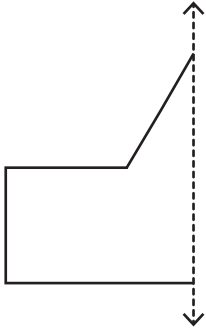

2)

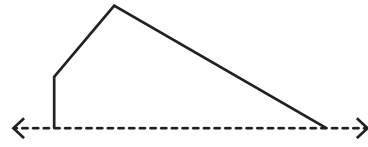

3)

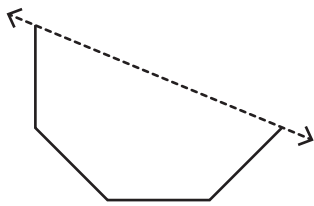

4)

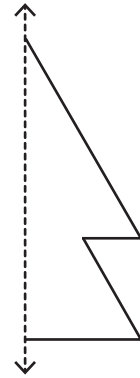

5)

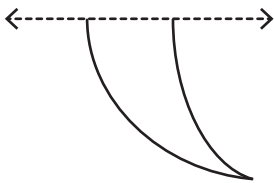

6)

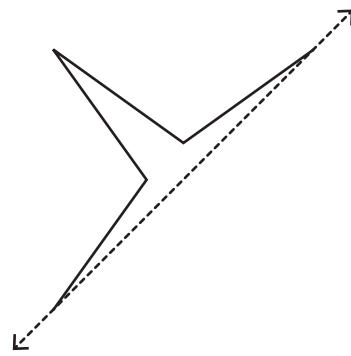

7)

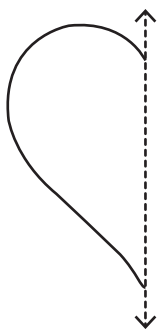

8)

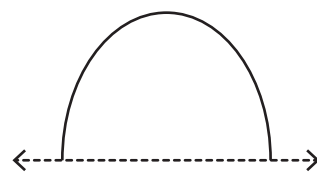

1)

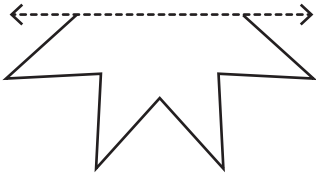

2)

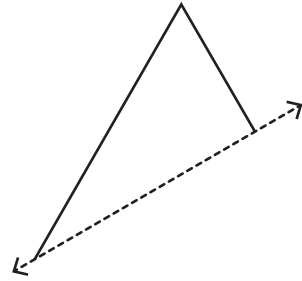

3)

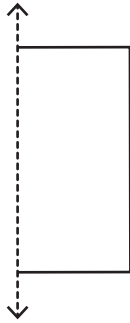

4)



5)

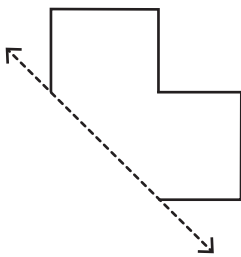

6)



7)



8)

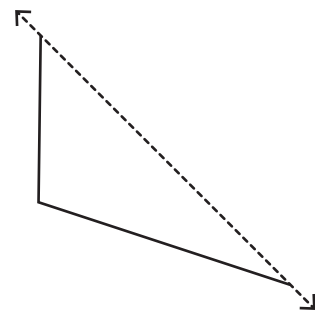

1)

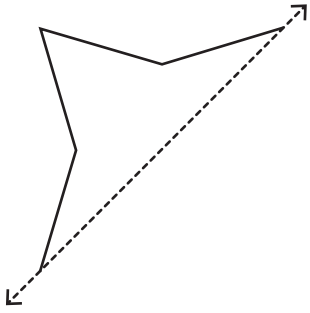

2)

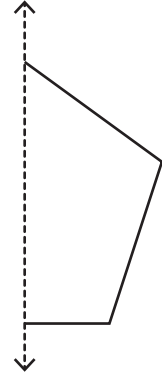

3)

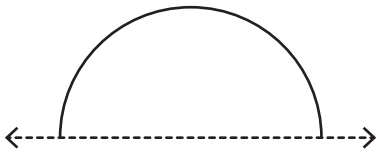

4)

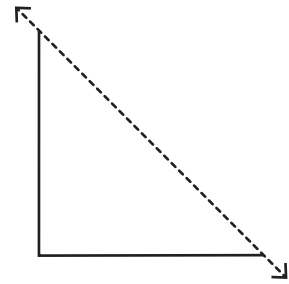

5)

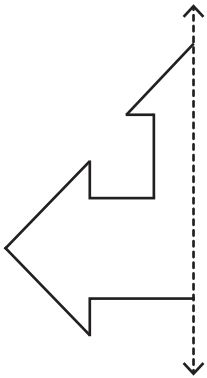

6)

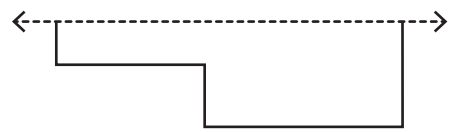

7)

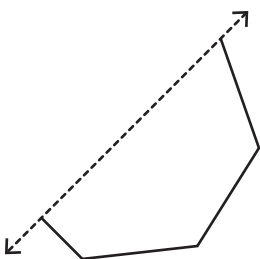

8)

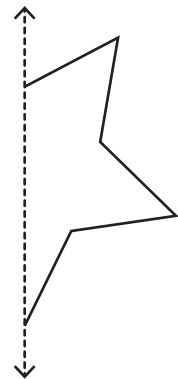

1)

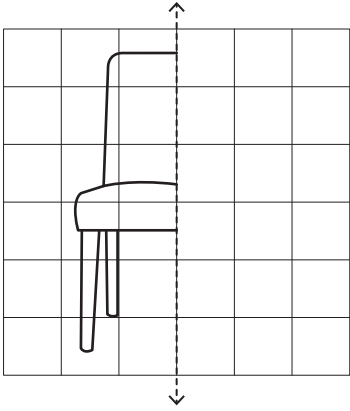

2)

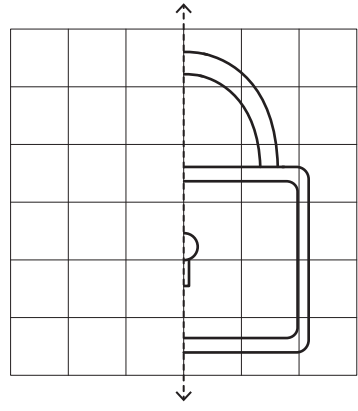

3)

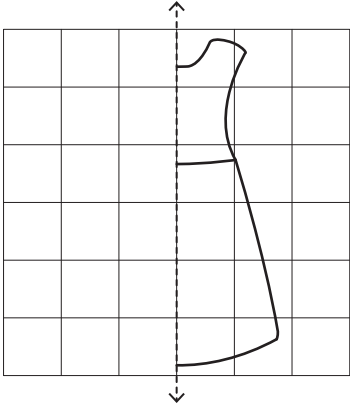

4)

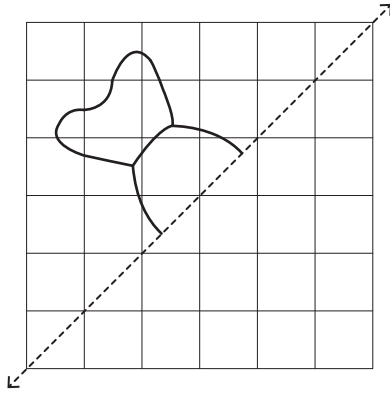

5)

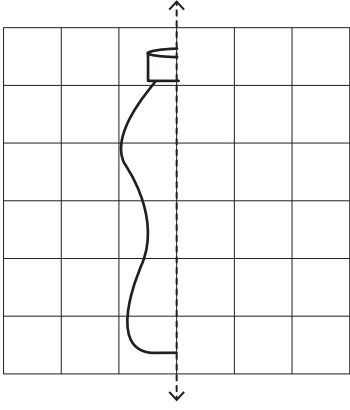

6)

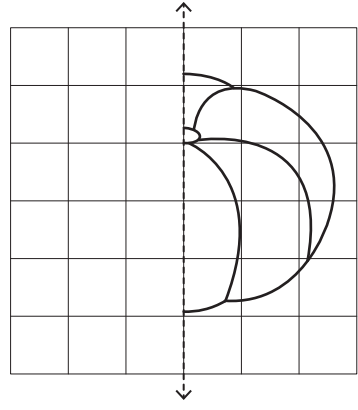

7)

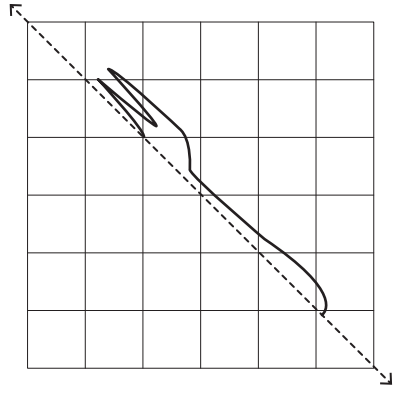

8)

